

MI3

Noncontact Temperature Measurement for Industrial Applications and OEMs

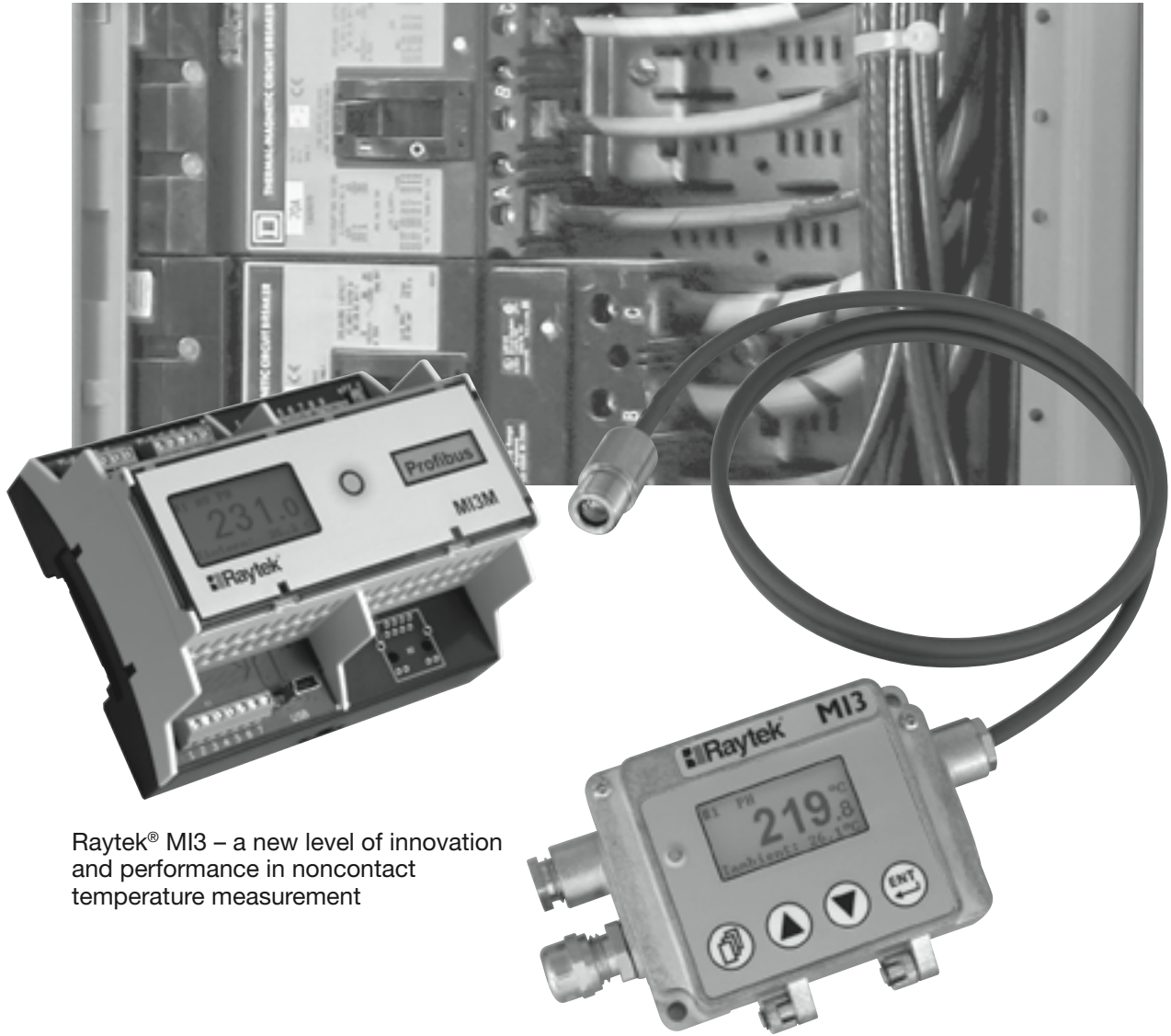

Raytek® MI3 – a new level of innovation and performance in noncontact temperature measurement

MI3 Highlights

- Optional network communications interfaces RS485, Modbus®, Profibus, Analog (NEW) all outputs with galvanic isolation (Analog DIN 6TE variant only):
 - from power supply
 - from channel to channel
- Innovative multi-sensor design—up to 8 sensing heads/ system, each individually addressable
- Fast response times of < 20 mSec
- Rugged IP65 rated sensing heads survive ambient temperatures up to 180°C (356°F) without cooling
- Intuitive user interface with high resolution LCD display for easy set-up
- Precision high resolution optics, up to 22:1
- User configurable analog outputs (0/4-20mA, 0-5/10V, type J, K, R or S t/c)
- Standard USB 2.0 digital interface for remote set-up
- Miniature sensing head fits where other sensors can't
- Isolated solid state alarm relay output
- Adjustable Emissivity, Peak Hold, Valley Hold and Averaging functions
- Datatemp® Multi-drop and field calibration software included
- Full range of accessories
- Automatic sensing head detection—plug and play

The Raytek® MI3 is a powerful two-piece infrared temperature measurement system with miniature sensing head and separate communications electronics. The sensor is small enough to be installed just about anywhere, yet it outperforms much larger systems. Available in either a rugged cast metal electronics enclosure, an innovative multi-channel DIN mountable enclosure, or low cost OEM configurations, the MI3 offers a host of advanced signal processing features you won't normally find in sensors costing much more.

Designed for an endless range of applications, the MI3 features a variety of sensing head options. Low temperature sensors with a measurement range of -40°C to 1000°C (-40°F to 1832°F), fast response (<20 mSec) sensors, provide an impressive array of solutions for your process needs. The rugged stainless steel sensing head ensures reliable long term performance in the harshest industrial environments. Although the MI3 sensor is small in size, it has all the performance you need— with 1% accuracy, a choice of high resolution optics up to 22:1 and user configurable I/O.

Standard features include adjustable Emissivity, Peak Hold, Valley Hold, and Averaging functions. All sensor parameters are easily adjustable on the built-in user interface keypad, or remotely with the Windows® 7 compatible DataTemp software via the built-in USB interface. Advanced features further extend the power of the MI3 and include user configurable alarm output, digital "recipe" table inputs that can be easily interfaced to an external control system, an external reset input for signal processing, and external inputs for analog emissivity adjustment or reflected energy compensation. Optional RS485, Modbus®, Profibus or Analog output network interfaces simplify intergration with a factory or machine control system.

The MI3's miniature size and low cost per measurement point make it ideal for installation at multiple points in your process. The MI3 is accurate, rugged, affordable, easy-to-install and operate. With the MI3, precision infrared temperature measurement is now an economical alternative.

Raytek MI3 – a new level of innovation and performance in noncontact temperature measurement!

Specifications

Ambient Temperature:			
LT, G5	-10°C to 120°C (14°F to 248°F)		
LTH	-10°C to 180°C (14°F to 356°F)		
Spectral Response:			
LT (Low Temp.)	8 to 14 microns	G5	5 microns
Optical Resolution:			
LTS	2:1, 10:1, 22:1	LTH	10:1, 22:1
LTF	10:1	G5	10:1
Temperature Range:			
LTS (2:1, 10:1)	-40°C to 600°C (-40°F to 1112°F)		
LTF (LTS 22:1)	0°C to 1000°C (32°F to 1832°F)		
LTH	-40°C to 600°C (-40°F to 1112°F)		
G5	250°C to 1650°C (482°F to 3002°F)		
System Accuracy:			
±1% of reading or ±1°C, whichever is greater			
Thermocouple output accuracy			
±1% of reading or ±2.5°C, whichever is greater			
System Repeatability:			
±0.5% of reading or ±0.5°C (1°F), whichever is greater			
Temperature Coefficient:			
±0.05%K per °K, or ±0.05% per °K* Tmes, whichever is greater			
System Response Time:			
LTS, LTH, G5	130ms (90%)		
LTF	20ms (90%)		
Emissivity:			
0.100 to 1.100 digitally adjustable			
Increments of .001			
Transmission:			
0.100 to 1.000 digitally adjustable			
Increments of .001			
Signal Processing:			
Peak hold, valley hold, variable averaging filter, adjustable up to 998 seconds			

*Scaled temperature dynamic range < 500°C (< 932°F)

Nominal Optical Specifications

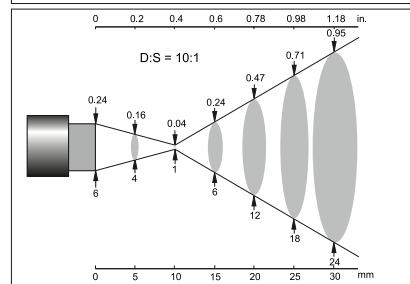
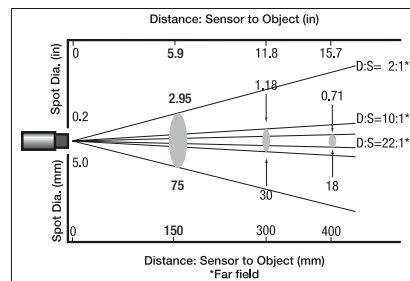

10:1 with Close Focus Accessory

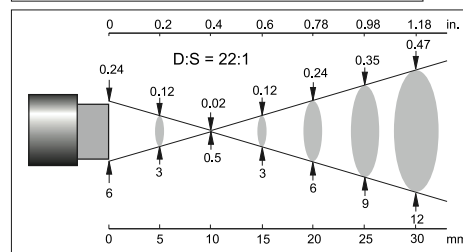

22:1 with Close Focus Accessory

D:S is the optical resolution expressed as a ratio of the distance to the measurement spot divided by the diameter of the spot.

Optical resolution for the MI3 is 2:1, 10:1, 22:1.

Nominal spot size based on 90% energy.

Electrical Specifications MI3COMM

Digital Interface	USB 2.0 (RS485, Modbus or Profibus optional)
Outputs:	Scaleable 4-20mA, 0-20mA, 0-10V, 0-5V, J, K, R or S thermocouple, 0-5V head ambient output
Inputs:	Digital inputs for emissivity control, ambient background temperature compensation, trigger/hold input
Alarm Relay:	48 VAC, 300 mA, optically isolated solid state relay
Construction:	
Comm box (MI3)	Zinc, die cast
Output Impedance (T/C output):	20 ohms
Minimum Load Impedance (mV output):	10K ohms
Maximum Loop Impedance (mV output):	500 ohms
Power Draw:	4W max
Power Supply:	8-32VDC
Environmental Rating:	IP 65 (NEMA-4)
Electronics Housing:	-10°C to 65°C (14°F to 150°F)
Storage Temperature:	-20°C to 85°C (-4°F to 185°F)
Relative Humidity:	10 to 95%, non-condensing
Electronics Weight:	270g (9.5oz)
EMI/EMC/ESD	IEC EN61326-1 1:2006

*Maximum total cable length of 30 m (98 ft) when used with XXXMI3CONNBOX Multichannel interface box

Electrical Specifications MI3MCOMM

Sensor Head Inputs	Maximum of 4
Digital Interface	USB 2.0 and RS485 standard. (Modbus or Profibus optional)
Outputs up to 4 channels (Analog MI3MCOMM Box)	Scaleable 4-20mA, 0-20mA, 0-10V, 0-5V, J, K, R or S thermocouple, 0-5V head ambient output galvanic isolation
Inputs:	Trigger input
Alarm Relay:	48 VAC, 300 mA, optically isolated
Construction:	
DIN Comm box (MI3M)	Molded plastic
Power Draw:	5W max
Power Supply:	8-32VDC
Electronics Housing:	-10°C to 65°C (14°F to 150°F)
Storage Temperature:	-20°C to 120°C (-4°F to 248°F)
Relative Humidity:	10 to 95%, non-condensing

*Maximum total cable length of 60m (197ft)

Sensing Head Specifications

Environmental Rating:	IP 65 (NEMA-4)
Storage Temperature:	-20°C to 85°C (-4°F to 185°F)
Relative Humidity:	10 to 95%, non-condensing
Construction:	
Sensing Head	Stainless Steel
Sensing head cable	PUR halogen free, flame retardant insulation, 125°C (257°F) max. temp
Weight:	
Sensing head (w/1 m cable)	50g (1.75oz)
Cable Length:	1m (3.3ft) standard, 3m (10ft), 8m (26ft), 15m (50ft) and 30m (98ft)
Shock (sensing head)	IEC 68-2-27 50g's, 11ms, 3 axis
Vibration (sensing head)	68-2-6 3g's, 11-200Hz, 3 axis
EMI/EMC/ESD	IEC EN61326-1 1:2006

Accessories

A full range of accessories for various applications and industrial environments are available. Accessories include items that may be ordered at any time and added on-site:

- (XXXSYS) 24 VDC, 1.2A Power supply
- (XXXMIACAB) Adjustable mounting bracket
- (XXXMIACFB) Fixed mounting bracket
- (XXXMIACMN) Sensor head mounting nut
- (XXXMIACAJ) Air purge jacket
- (XXXMIACCJ) Air cooling system with .8 m (2.6 ft) air hose or with (XXXMIACCJ1) 2.8 m (9.2 ft) air hose
- (XXXMIACRAJ, XXXMIACRAJ1) Right angle mirror
- (XXXMIACPW, XXXMI3ACPWP) Protective windows
- (XXXMI3ACCFL) Close focus lens
- (XXXMI3CONNBOX) Multi-channel sensor interface box for use with MI3COMM Box
- (XXXUSB485) USB/RS485 Adapter for boxes with RS485 interface

Sensor Dimensions

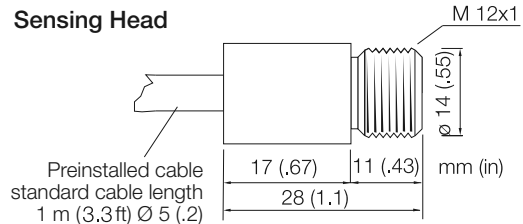

MI3 Electronics Housing

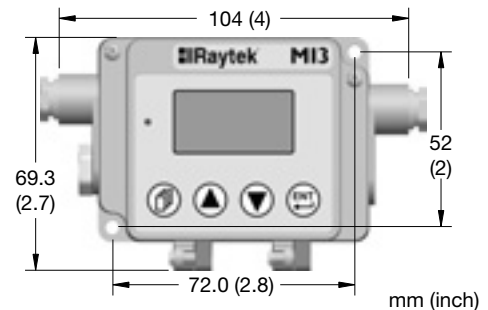

MI3M Multi-channel Electronics Housing

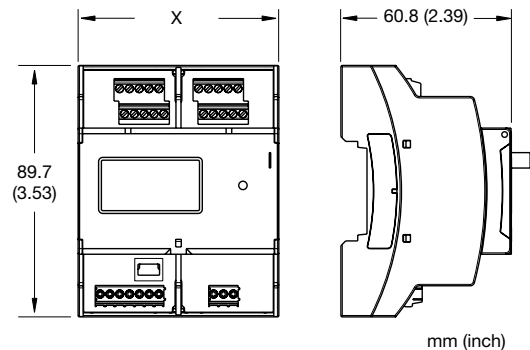

X Dimension

54 mm (2.1 in)

72 mm (2.8 in)

108 mm (4.3 in)

Models

RAYMI3MCOMM

RAYMI3COMM

All other models

